

# 7.4 EPIC® ZYLIN R 3.0

Rundsteckverbinder / Circular connector / Connecteur circulaire

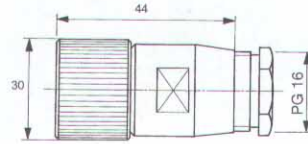

## Bauform D6 (Stecker, Kabelverschraubung)

Style D6 (Connector, cable gland)

Modèle D6 (Connecteur, presse-étoupe)

Artikel part article	Art.Nr. part No. N° art.	Codierung Coding Codage	VPE packing unit conditionnement
R3,0 D	202040AF	N	5

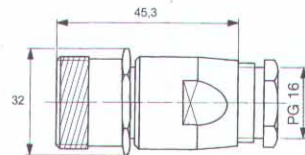

## Bauform F6 (Kupplung, Kabelverschraubung)

Style F6 (Cable connector, cable gland)

Modèle F6 (Prolongateur, presse-étoupe)

Artikel part article	Art.Nr. part No. N° art.	Codierung Coding Codage	VPE packing unit conditionnement
R3,0 F	202050AF	N	5

- Hinweis:** Bei Bestellung Gehäuse + Einsatz (Kombinummer) angeben  
Beispiel für Bestellung (Gehäuse + Isolierkörper -> 202010AA + 40200121); bereits montiert
- Note:** Please order with combination number (housing+insert)  
Example for order (Housing + Insulation body -> 202010AA + 40200121); just fixed in the housing
- Remarque:** S'il vous plaît commandez avec un numéro de combinaison (boîtiers + inserts)  
Exemple pour commande (Boîtier + isolant-> 202010AA + 40200121); justement à monté

# 7.4 EPIC® ZYLIN R 3.0

Rundsteckverbinder / Circular connector / Connecteur circulaire

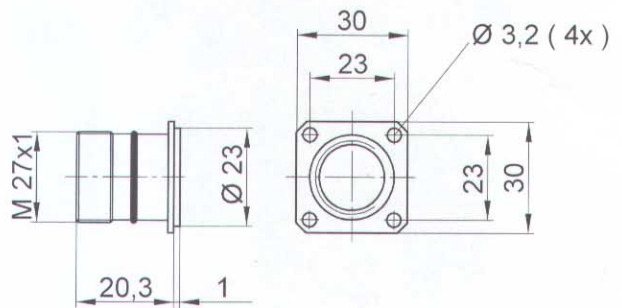

## Bauf orm A Einbaudose (Frontmontage)

Style A panel mount base (front assembly)

Modèle A Embase encastrée (montage frontal)

Artikel part article	Art.Nr. part No. N° art.	Codierung Coding Codage	VPE packing unit conditionnement
R3,0 A	202010AA	N	5

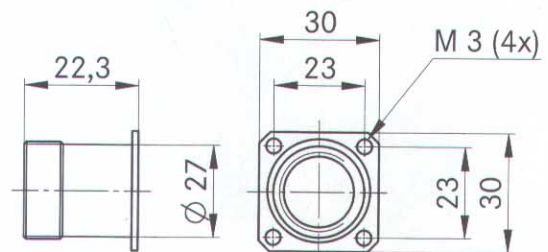

## Bauf orm B1 Einbaudose (Hinterwandmontage)

Style B1 panel mount base (back-wall assembly)

Modèle B1 Embase encastrée (montage sur paroi arrières)

Artikel part article	Art.Nr. part No. N° art.	Codierung Coding Codage	VPE packing unit conditionnement
R3,0 B1	202020AA	N	5

- Hinweis:** Bei Bestellung Gehäuse + Einsatz (Kombinummer) angeben  
Beispiel für Bestellung (Gehäuse + Isolierkörper -> 202010AA + 40200121); bereits montiert
- Note:** Please order with combination number (housing+insert)  
Example for order (Housing + Insulation body -> 202010AA + 40200121); just fixed in the housing
- Remarque:** S'il vous plaît commandez avec un numéro de combinaison (boîtiers + inserts)  
Exemple pour commande (Boîtier + isolant-> 202010AA + 40200121); justement à monté

# 7.4 EPIC® ZYLIN R 3.0

Rundsteckverbinder / Circular connector / Connecteur circulaire

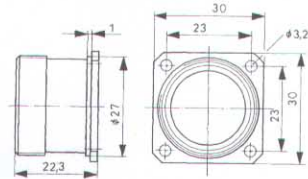

## Bauform B2 Einbaudose (Hinterwandmontage)

Style B2 panel mount base (back-wall assembly)

Modèle B2 Embase encastrée (montage sur paroi arrière)

Artikel part article	Art.Nr. part No. N° art.	Codierung Coding Codage	VPE packing unit conditionnement
R3,0 B2	202030AA	N	5

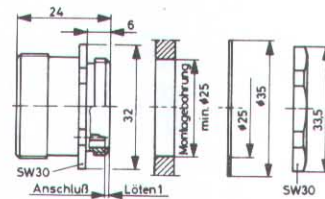

## Bauform G1 Einbaudose (Einlochmontage)

Style G1 panel mount base (single hole assembly)

Modèle G1 Embase encastrée (prise avec écrou de fixation)

Artikel part article	Art.Nr. part No. N° art.	Codierung Coding Codage	VPE packing unit conditionnement
R3,0 G1	202060AA	N	5

- Hinweis:** Bei Bestellung Gehäuse + Einsatz (Kombinummer) angeben  
 Beispiel für Bestellung (Gehäuse + Isolierkörper -> 202010AA + 40200121); bereits montiert
- Note:** Please order with combination number (housing+insert)  
 Example for order (Housing + Insulation body -> 202010AA + 40200121); just fixed in the housing
- Remarque:** S'il vous plaît commandez avec un numéro de combinaison (boîtiers + inserts)  
 Exemple pour commande (Boîtier + isolant-> 202010AA + 40200121); justement à monté

# 7.4 EPIC® ZYLIN R 3.0

Rundsteckverbinder / Circular connector / Connecteur circulaire

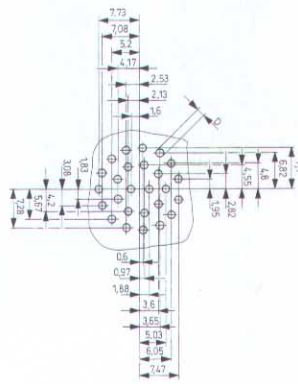
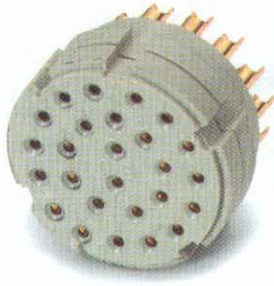

26 contacts

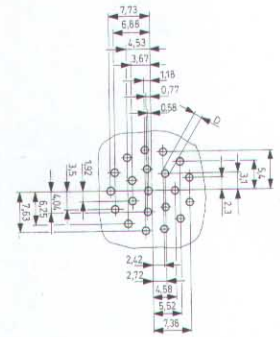

21 contacts

## Isolierkörper Insulation body Isolant

Ansicht steckseitig view from mating side vue côté de connection	Kontakte contacts contacts	Isolierkörper + Stiftkontakte Löt insulation body + male contacts solder mâle à souder	Isolierkörper + Buchsenkontakte Löt insulation body + female contacts solder isolant + contacts femelle à souder	Isolierkörper + Stiftkontakte Einlöt insulation body + male contacts PCB solder isolant + contacts mâle à souder sur ci	Isolierkörper + Buchsenkontakte Einlöt insulation body + female contacts PCB solder isolant + contacts femelle à souder sur ci	Für Bauform for model pour modèle	VPE packing unit conditionnement
--	----------------------------------	--	--	---	--	---	--

P-Teil / P-Part / P-Pièce  
Linksdrehend / turning anti-clockwise / rotation à gauche

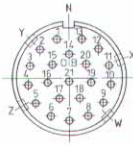

21  
21

40250121

A/B/D/F/G 5

40264121

A/B 5



26  
26

40250126

A/B/D/F/G 5

40264126

A/B 5

E-Teil / E-Part / E-Pièce  
Rechtsdrehend / turning clockwise / rotation à droite

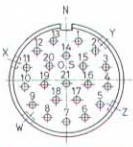

21  
21

40200121

A/B/D/F/G 5

40212121

A/B 5

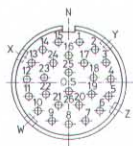

26  
26

40200126

A/B/D/F/G 5

40212126

A/B 5

- Hinweis:** Bei Bestellung Gehäuse + Einsatz (Kombinummer) angeben  
Beispiel für Bestellung (Gehäuse + Isolierkörper -> 202010AA + 40200121); bereits montiert
- Note:** Please order with combination number (housing+insert)  
Example for order (Housing + Insulation body -> 202010AA + 40200121); just fixed in the housing
- Remarque:** S'il vous plaît commandez avec un numéro de combinaison (boîtiers + inserts)  
Exemple pour commande (Boîtier + isolant-> 202010AA + 40200121); justement à monté

# 7.4 EPIC® ZYLIN R 3.0

Rundsteckverbinder / Circular connector / Connecteur circulaire

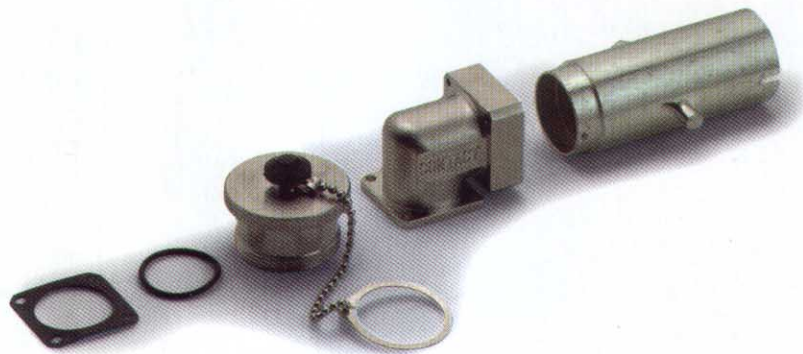

## Zubehör und Ersatzteile

Accessories

Accessoires

Artikel part article	Art.Nr. part No. N° art.	Für Bauform for model pour modèle					VPE packing unit conditionnement
		A1	B2	D6	F6	G1	
Flanschdichtung Flat gasket Joint plat	50201203	●					5
	50202203		●				5
Dichtring Sealing ring Anneau d'étanchéité	50206204					●	5
Metallschraubkappe Metal screw cap Bouchon d'étanchéité métallique	50201120	●					5
	50203120		●				5
	50204121			●			5
	50205121				●		5
Winkelgehäuse Angled housing Boîtier à 90° degré	502012AC	●					5
Montage/Werkzeug Assembly tool Outil assemblage	50200800			●	●		1